



STAIR PARTS





Koetter Woodworking is proud to be the Midwest's leading manufacturer of quality architectural wood products.

For over half a century, we have provided products and solutions for the residential and commercial building industry as well as fine furniture and cabinet manufacturers.

In addition to the products we manufacture, we proudly partner with a variety of supply chains, allowing us to be your one-stop source for mouldings, doors, stair components, specialty millwork and more.

Rail, Shoe & Fillet	2
---------------------------	---

NEWELS

Box Newels	3
Farmhouse Newels	5
Post To Post Newels	6-7
Over The Post Newels	9

BALUSTERS

Lite Iron Balusters	10-15
Mega Lite Iron Balusters	16
Wood Balusters	18-19
Fittings	20-21
Treads, Risers & Accessories	22-23
Starting Steps	23
Hardware	24

In addition to Stair Parts, Koetter Woodworking supplies a full line of Architectural Millwork Stile & Rail Wood Doors. Please visit www.koetterwoodworking.com to view any of our complete catalogs.

**ARCHITECTURAL
MILLWORK**



SOLID WOOD DOORS



STAIR PARTS



RAIL, SHOE & FILLET

Visit www.koetterwoodworking.com/envisionIT.html for additional custom handrail profiles

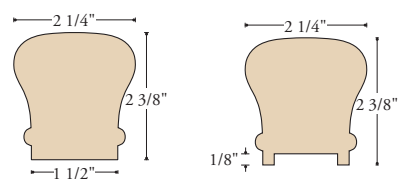

K-6010-ST

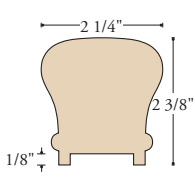

K-6010-ST-P1
1-1/4" plow

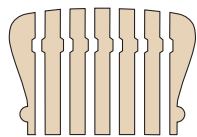

K-6010-B
Includes bending mould

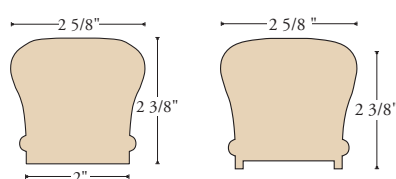

K-6210-ST

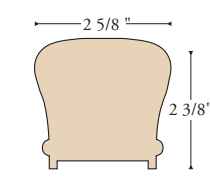

K-6210-ST-P1
1-3/4" plow

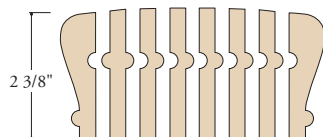

K-6210-B
Includes bending mould

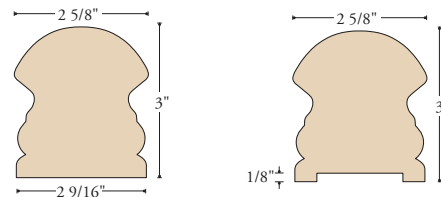

K-6519-ST

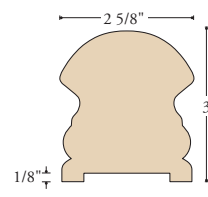

K-6519-ST-P1
1-3/4" plow

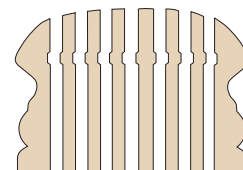

K-6519-B
Includes bending mould

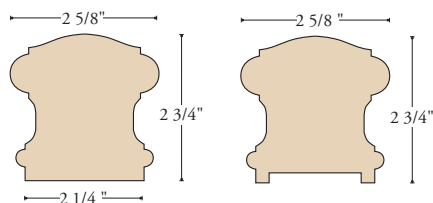

K-6710-ST

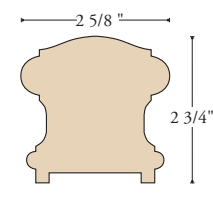

K-6710-ST-P1
1-3/4" plow

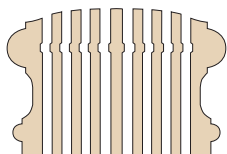

K-6710-B
Includes bending mould

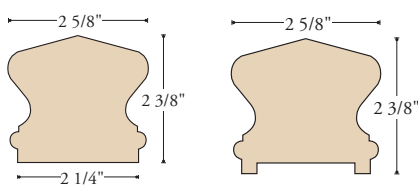

K-6910-ST

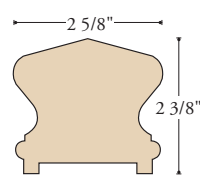

K-6910-ST-P1
1-3/4" plow

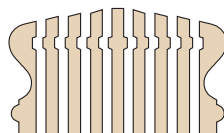

K-6910-B
Includes bending mould

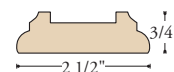

K-6045
1-1/4" plow

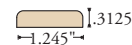

K-6000



K-6006
1-3/4" plow

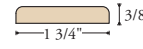

K-6007

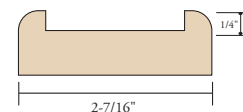

*K-6002-P1
1-3/4" plow

ADDITIONAL RAIL PROFILES (BENDING RAIL & FITTINGS NOT AVAILABLE)

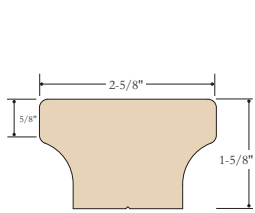

K-6085-ST

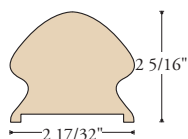

*K-6005-ST-P1
1-3/4" plow

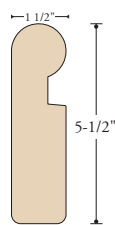

K-6035

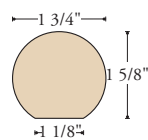

K-6040

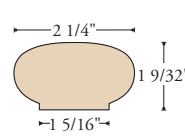

K-6042

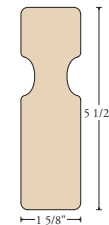

K-6300

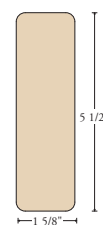

*K-6301

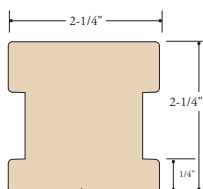

K-6350-ST

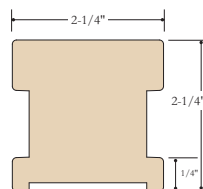

K-6350-ST-P1
1-3/4" plow

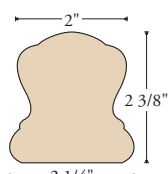

K-6510-ST

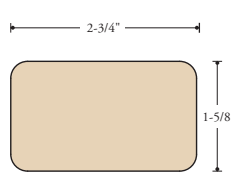

*K-6700

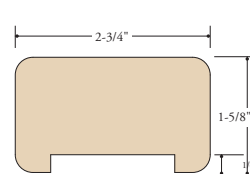

*K-6700-P1
1-3/4" plow

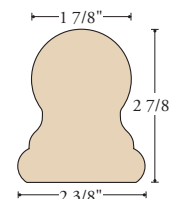

K-6810-ST

* = These handrail profiles may not comply with your local building codes.

BOX NEWELS

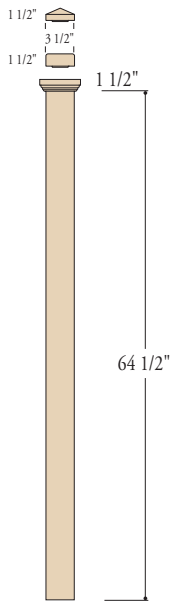

K-4075*
3-1/2" X 64-1/2"

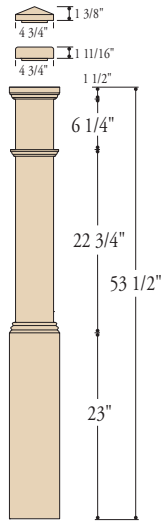

K-4091*
6-1/4" X 53-1/2"

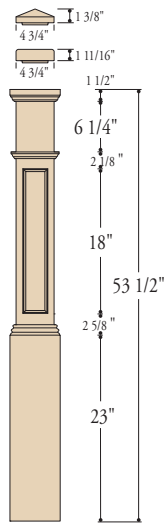

K-4091-FP*
6-1/4" X 53-1/2"

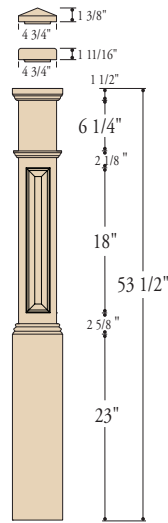

K-4091-RP*
6-1/4" X 53-1/2"

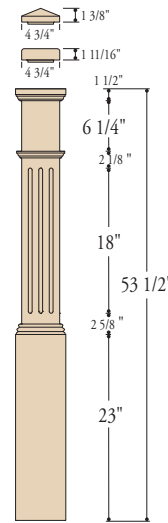

K-4091-F*
6-1/4" X 53-1/2"

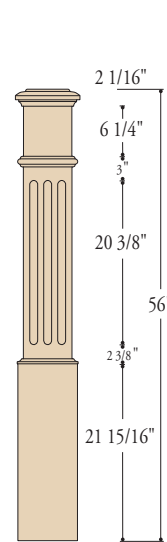

K-4095-F
7-1/2" X 56"

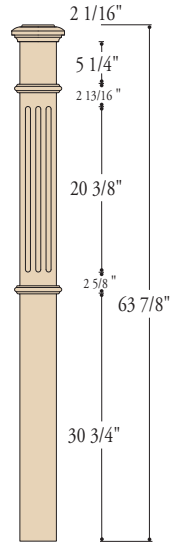

K-4695-F
4-1/2" X 63-7/8"

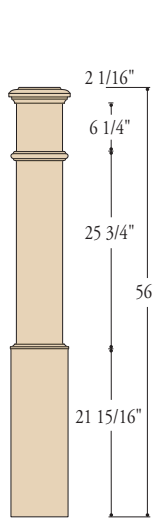

K-4095
7-1/2" X 56"

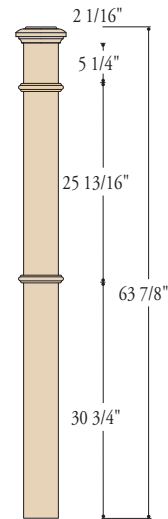

K-4695
4-1/2" X 63-7/8"

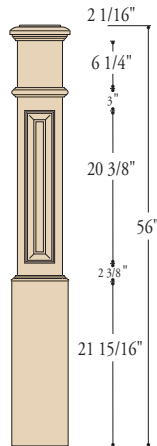

K-4891-RP
7-1/2" X 56"

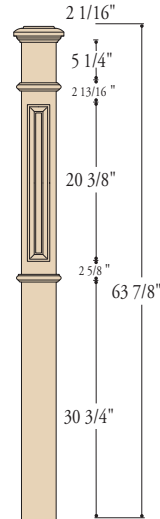

K-4691-RP
4-1/2" X 63-7/8"

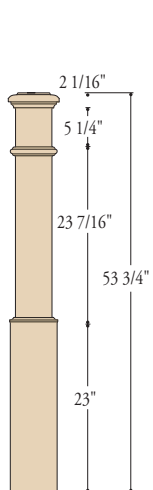

K-4090
6-1/4" X 53-3/4"

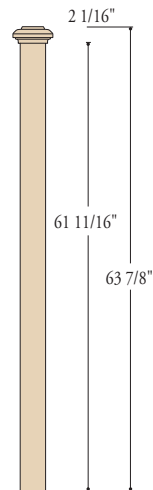

K-4077
3-1/2" X 63-7/8"

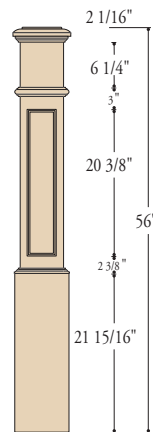

K-4891-FP
7-1/2" X 56"

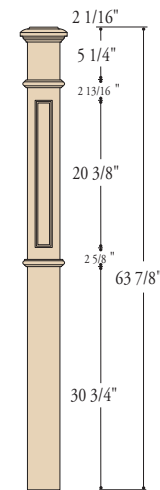

K-4691-FP
4-1/2" X 63-7/8"

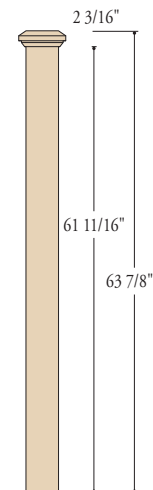

K-4690
4-1/2" X 63-7/8"



*These Box Newels are shipped with interchangeable flat and peak caps.

Mounting block and lag screws are included with all hollow box newels.

All box newels which are 4-1/2" and larger are hollow.



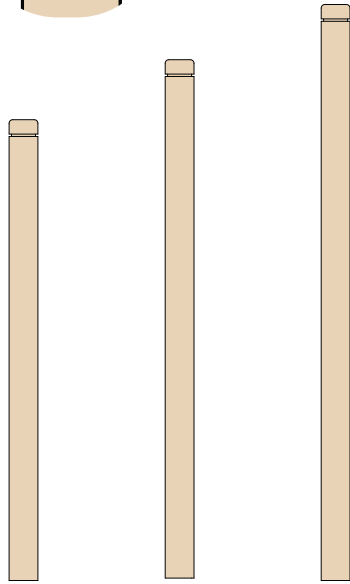
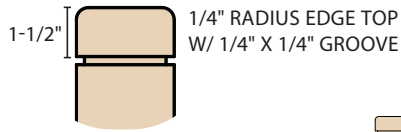

K-4102-48 3" X 3" X 48"
K-4102-54 3" X 3" X 54"
K-4102-60 3" X 3" X 60"

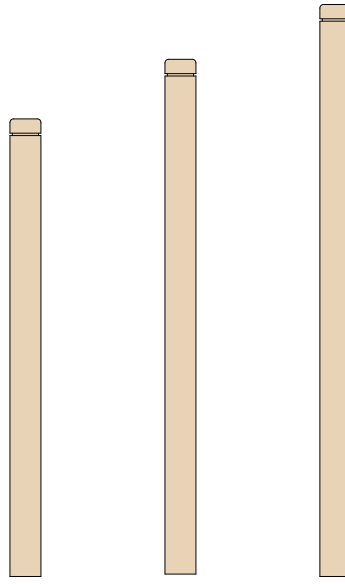

K-4202-48 3-1/4" X 3-1/4" X 48"
K-4202-54 3-1/4" X 3-1/4" X 54"
K-4202-60 3-1/4" X 3-1/4" X 60"

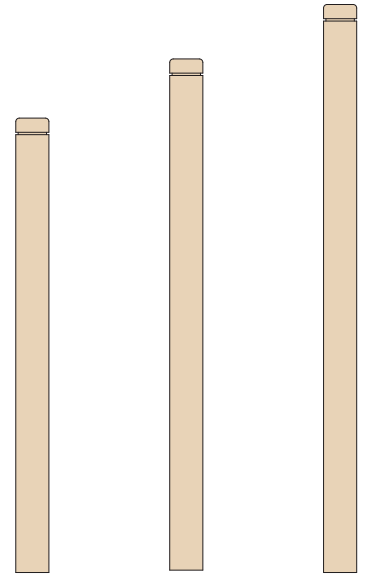

K-4302-48 3-1/2" X 3-1/2" X 48"
K-4302-54 3-1/2" X 3-1/2" X 54"
K-4302-60 3-1/2" X 3-1/2" X 60"

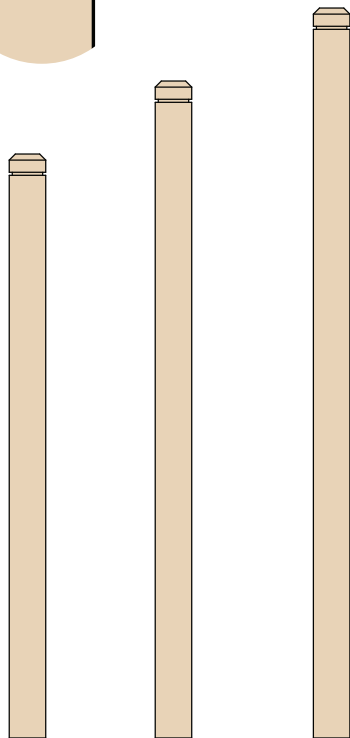

K-4402-48 3" X 3" X 48"
K-4402-54 3" X 3" X 54"
K-4402-60 3" X 3" X 60"

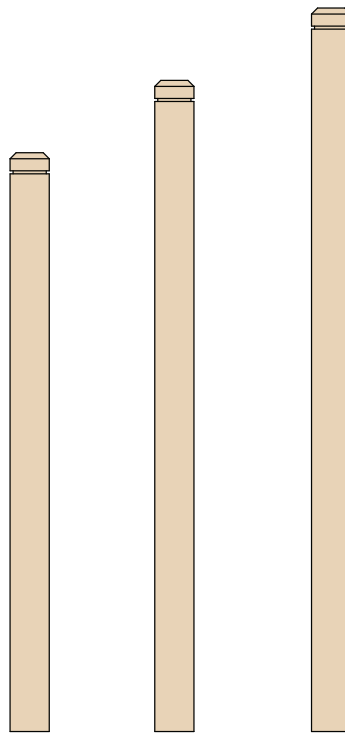

K-4502-48 3-1/4" X 3-1/4" X 48"
K-4502-54 3-1/4" X 3-1/4" X 54"
K-4502-60 3-1/4" X 3-1/4" X 60"

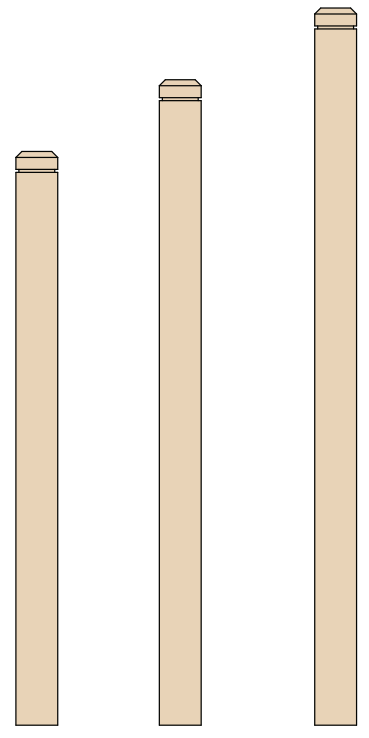

K-4602-48 3-1/2" X 3-1/2" X 48"
K-4602-54 3-1/2" X 3-1/2" X 54"
K-4602-60 3-1/2" X 3-1/2" X 60"

POST TO POST NEWELS

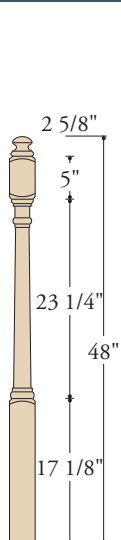

K-4040
3" X 48"
STARTING

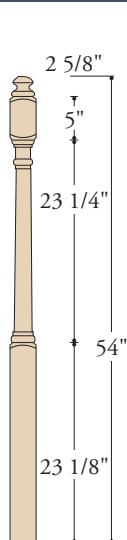

K-4042
3" X 54"
STARTING

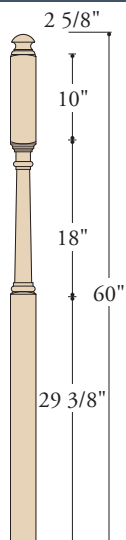

K-4045
3" X 60"
LANDING

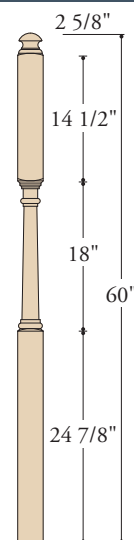

K-4046
3" X 60"
LANDING

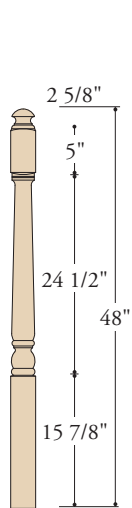

K-4040-A
3" X 48"
STARTING

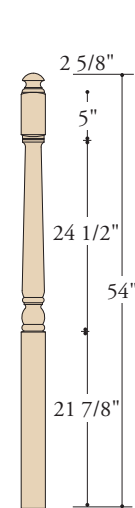

K-4042-A
3" X 54" (F)
STARTING

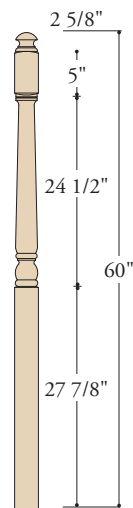

K-4043-A
3" X 60" (F)
STARTING

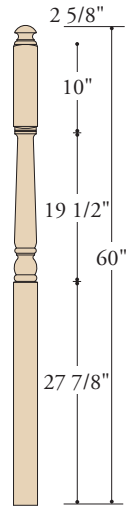

K-4045-A
3" X 60" (F)
LANDING

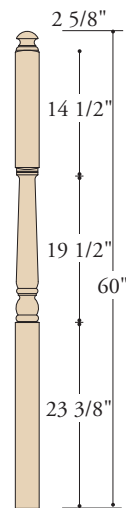

K-4046-A
3" X 60" (F)
LANDING



All "404X" newel posts featured on this page are available with a ball top. Specify BT when ordering.

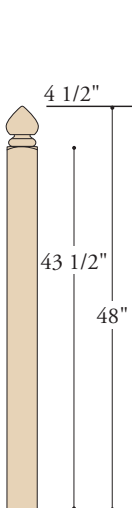

K-4004
3-1/2" X 48"
STARTING

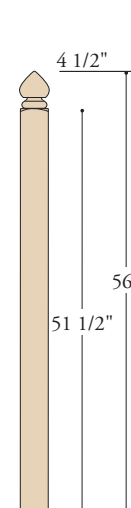

K-4005
3-1/2" X 56"
LANDING

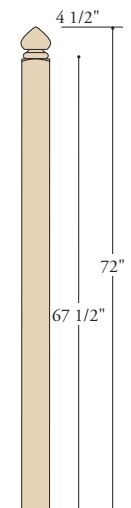

K-4006
3-1/2" X 72"
LANDING

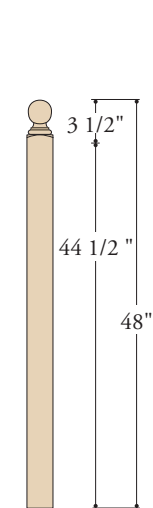

K-4004-BT
3-1/2" X 48"
STARTING

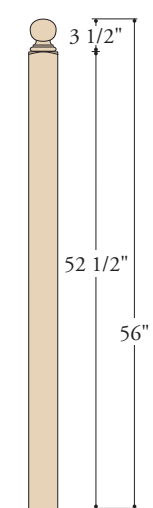

K-4005-BT
3-1/2" X 56"
LANDING



Reeded (R)



Fluted (F)



Twisted (T)



Octagonal (O)

Several balusters and newels are also available in Reeded, Twisted, Fluted, and Octagonal as designated with a **R** (Reeded), **T** (Twisted), **F** (Fluted), or **O** (Octagonal) below the corresponding part numbers. Call for pricing and lead times.

POST TO POST NEWELS

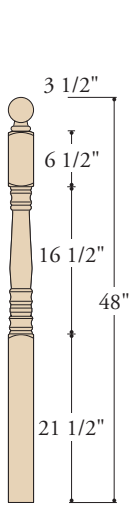

K-4300
3" X 48"
STARTING

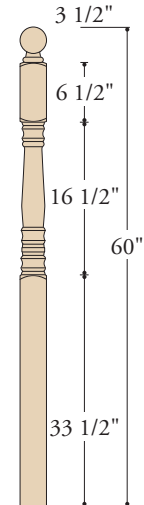

K-4304
3" X 60"
STARTING/LANDING

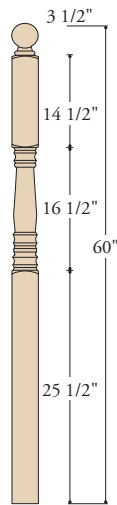

K-4305
3" X 60"
LANDING

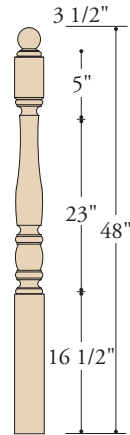

K-5548
3-1/2" X 48"
(F, R, O)
STARTING

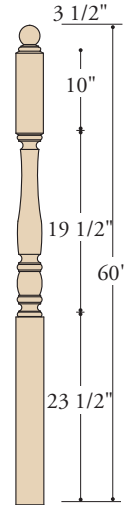

K-5545
3-1/2" X 60"
(F, R, O)
LANDING

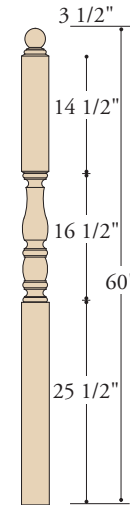

K-5546
3-1/2" X 60"
(F, R, O)
LANDING

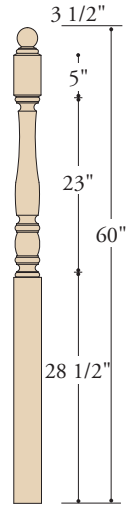

K-5560
3-1/2" X 60"
(F, R, O)
STARTING/LANDING

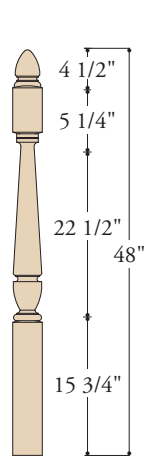

K-3030-ST
3-1/2" X 48"
(F, T, O)
STARTING

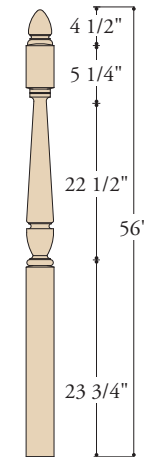

K-3042-ST
3-1/2" X 56"
(F, T, O)
STARTING/LANDING

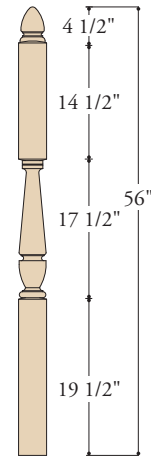

K-3046-ST
3-1/2" X 56"
(F, T, O)
LANDING

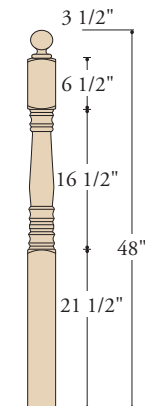

K-4500
3-1/2" X 48" (O)
STARTING

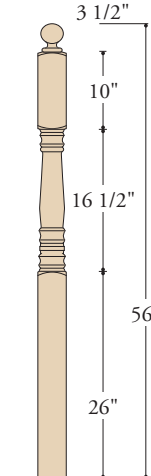

K-4503
3-1/2" X 56" (O)
LANDING

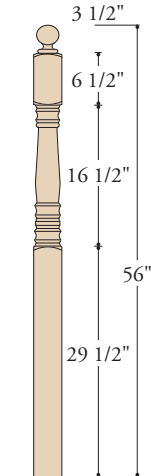

K-4504
3-1/2" X 56" (O)
STARTING/LANDING

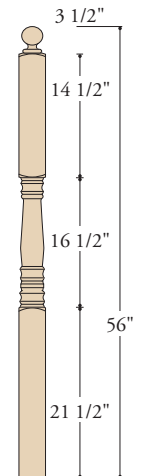

K-4505
3-1/2" X 56" (O)
STARTING

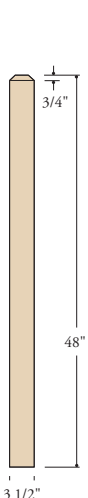

K-4002-48
3-1/2" X 48"
STARTING

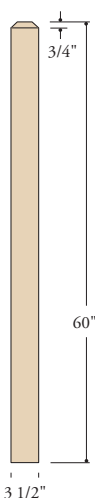

K-4002-60
3-1/2" X 60"
LANDING

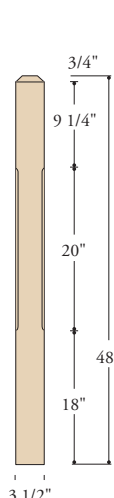

K-4002-C-48
3-1/2" X 48"
STARTING

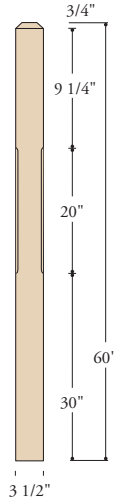

K-4002-C-60
3-1/2" X 60"
LANDING

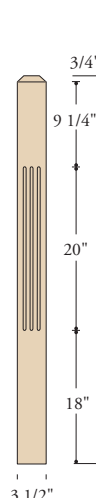

K-4002-F-48
3-1/2" X 48"
STARTING

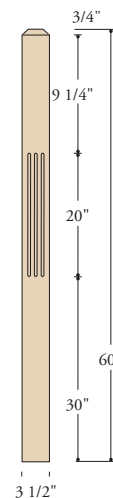

K-4002-F-60
3-1/2" X 60"
LANDING



K-4003-S4S 48
3-1/2" X 48"
S4S SQUARE



K-4003-S4S 60
3-1/2" X 60"
S4S SQUARE



OVER THE POST NEWELS

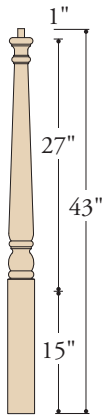

K-4010
3" X 43" (F)
STARTING
(Square Base)

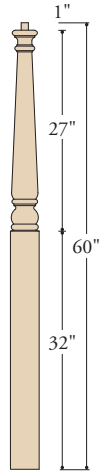

K-4015
3" X 60" (F)
LANDING
(Square Base)

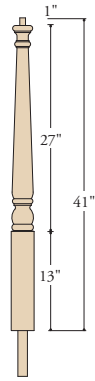

K-4050-RB
3" X 41" (F)
STARTING
(Round base, loose dowel)

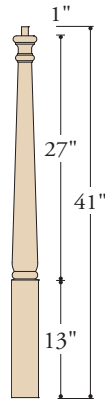

K-4061-41
3" X 41"
STARTING
(Square Base)

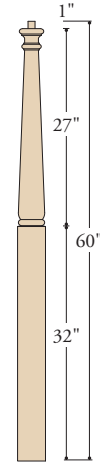

K-4061-60
3" X 60"
LANDING
(Square Base)

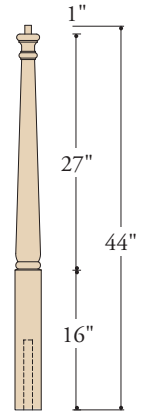

K-4061-RB
2-3/4" X 44"
STARTING
(Round base, loose dowel)

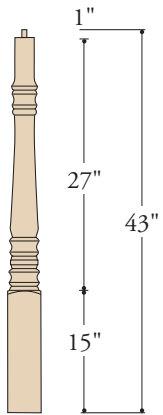

K-4270
3-1/2" X 43" (O)
STARTING
(Square Base)

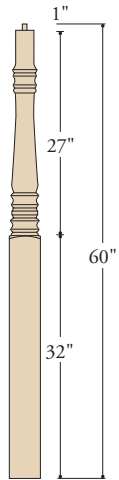

K-4275
3-1/2" X 60" (O)
LANDING
(Square Base)

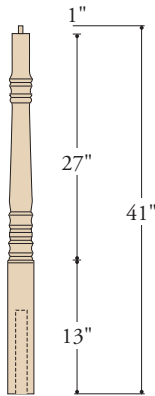

K-4272-RB
3-1/2" X 41" (O)
VOLUTE
(Round base, loose dowel)

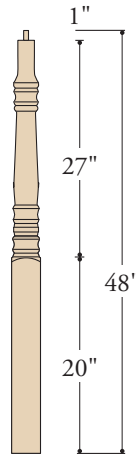

K-4271
3-1/2" X 48" (O)
STARTING
(Square Base)

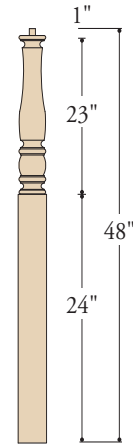

K-5511
3-1/2" X 48" (F, R, O)
STARTING
(Square Base)

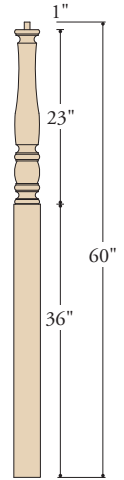

K-5515
3-1/2" X 60" (F, R, O)
LANDING
(Square Base)

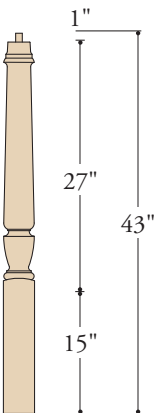

K-3010
3-1/2" X 43" (F, T)
STARTING
(Square Base)

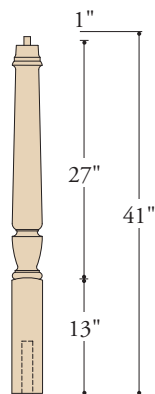

K-3012
3-1/2" X 41" (F, T)
STARTING
(Square base, loose dowel)

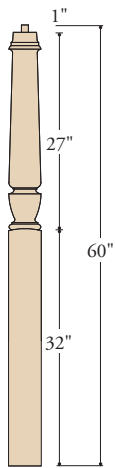

K-3015
3-1/2" X 60" (F, T)
LANDING
(Square Base)



Reeded (R) Fluted (F) Twisted (T) Octagonal (O)

Several balusters and newels are also available in Reeded, Twisted, Fluted, and Octagonal as designated with a **R** (Reeded), **T** (Twisted), **F** (Fluted), or **O** (Octagonal) below the corresponding part numbers. Call for pricing and lead times.

LITE IRON BALUSTERS



K-9000TB-44"
1/2"



K-9001TB-44"
1/2"



K-9080TB-44"
1/2"



K-9002TB-44"
1/2"



K-9003TB-44"
1/2"



K-9004TB-44"
1/2"

AVAILABLE FINISHES

Colors shown may vary due to the translation and reproduction limitations of photography.



Satin Black



Ash Gray



Flat Black



Copper Vein



Silver Vein



Oil Rubbed Bronze



Oil Rubbed Copper

LITE IRON BALUSTERS



K-9005TB-44"
1/2"



K-9008TB-44"
1/2"



K-9009TB-44"
1/2"



K-9055SS-44"
1/2"



K-9057SS-44"
1/2"



K-9010RS-44"
1/2"



K-9011RS-44"
1/2"



K-9012RS-44"
1/2"



K-9013RS-44"
1/2"



K-9014RS-44"
1/2"



K-9015RS-44"
1/2"



SBL K-9068RB-96
9/16" x 96", Round, Hollow Bar, Satin Black



LITE IRON BALUSTERS



K-9050VS-44



K-9051VS-44



K-9087CS-44

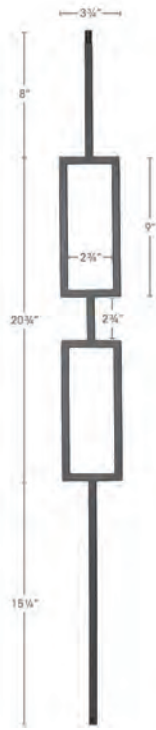

K-9091CS-44



K-9093CS-44



K-9089CS-44



K-9088CS-44



LITE IRON BALUSTERS

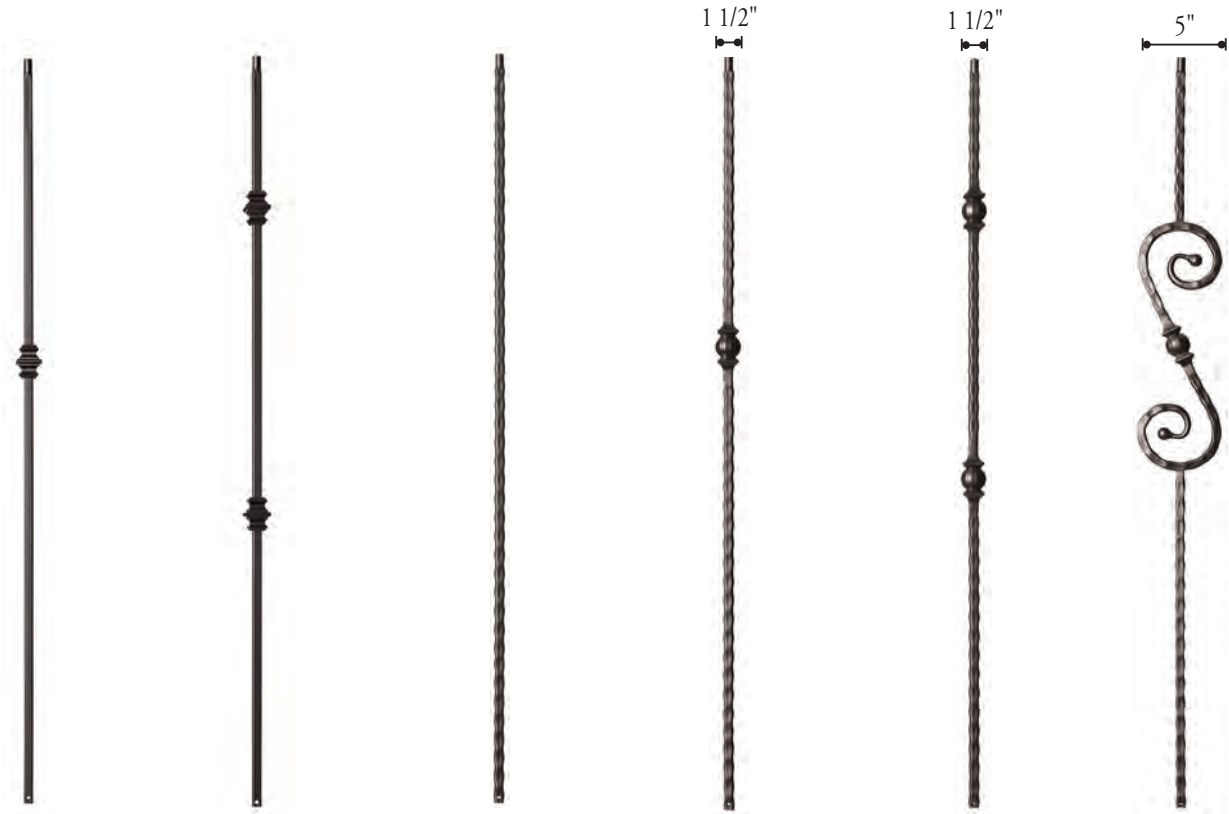

K-9006TB-44"
1/2"

K-9007TB-44"
1/2"

K-9031HF-44"
9/16"

K-9032HF-44"
9/16"

K-9033HF-44"
9/16"

K-9034HF-44"
9/16"

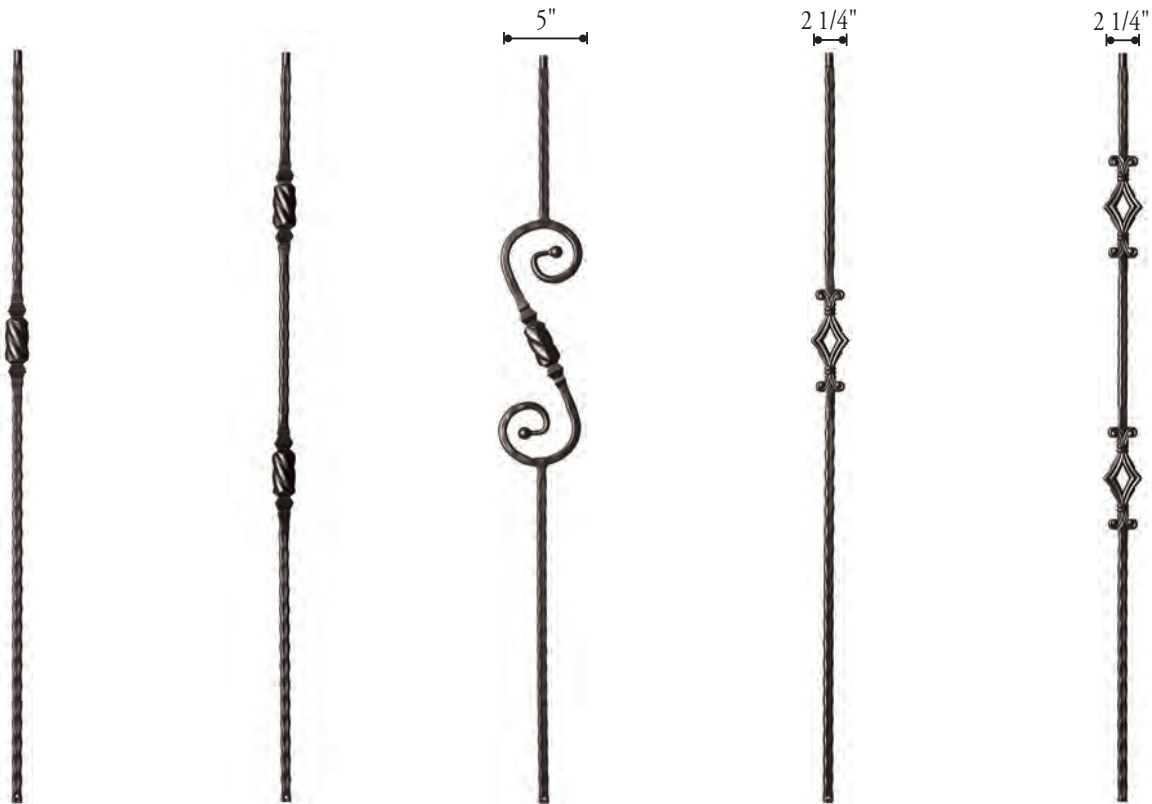

K-9045HF-44"
9/16"

K-9046HF-44"
9/16"

K-9047HF-44"
9/16"

K-9040HF-44"
9/16"

K-9041HF-44"
9/16"

LITE IRON BALUSTERS

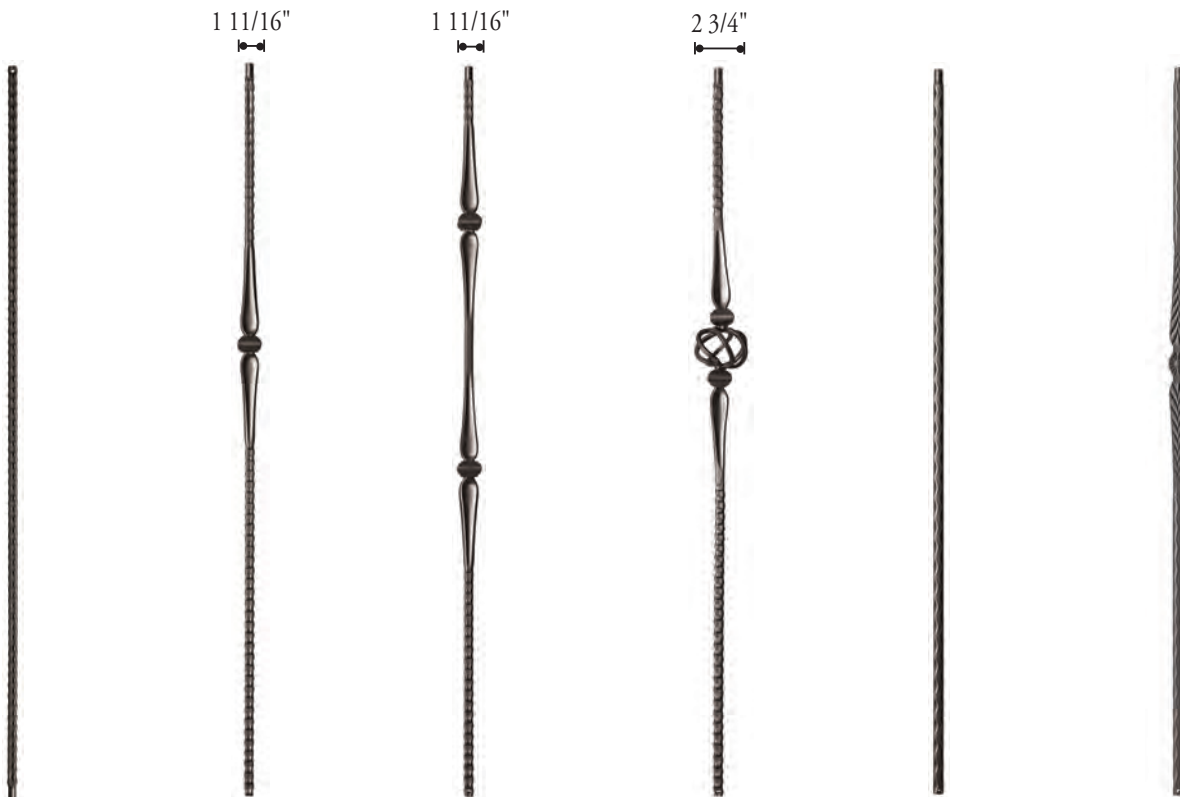

K-9016HG-44"
9/16"

K-9017HG-44"
9/16"

K-9018HG-44"
9/16"

K-9019HG-44"
9/16"

K-9020HE-44"
9/16"

K-9021HE-44"
9/16"



K-9022HE-44"
9/16"

K-9023HE-44"
9/16"

K-9024HE-44"
9/16"

ACCESSORIES



Base Shoe
K-9061BS - 1/2"
K-9061BS - 9/16"



Base Shoe w/Set Screw
K-9062BS - 1/2"
K-9062BS - 9/16"
K-9062BS - 3/4"



Rake Shoe w/Set Screw
K-9063RS - 1/2"
K-9063RS - 9/16"
K-9063RS - 3/4"

53° angle



Adjustable Knuckle
K-9064AK - 1/2"
K-9064AK - 9/16"



Flat Square Shoe
K-9065FS - 1/2"
K-9065FS - 9/16"



Shoe w/Down Ears
K-9066DE - 1/2"
K-9066DE - 9/16"



Flat Round w/Insert
K-9067EF-FR
Universal



Flat Square w/Insert
K-9067EF-FS
Universal



K-5912 Insert
.42"x.42"x2"
(for 1/2" Balusters)

3/4" MEGA LITE IRON BALUSTERS



K-9900TB-44"
3/4"



K-9901TB-44"
3/4"



K-9902TB-44"
3/4"



K-9903TB-44"
3/4"



K-9904TB-44"
3/4"



K-9906TB-44"
3/4"



K-9907TB-44"
3/4"



K-9981TB-44"
3/4"



BALUSTERS

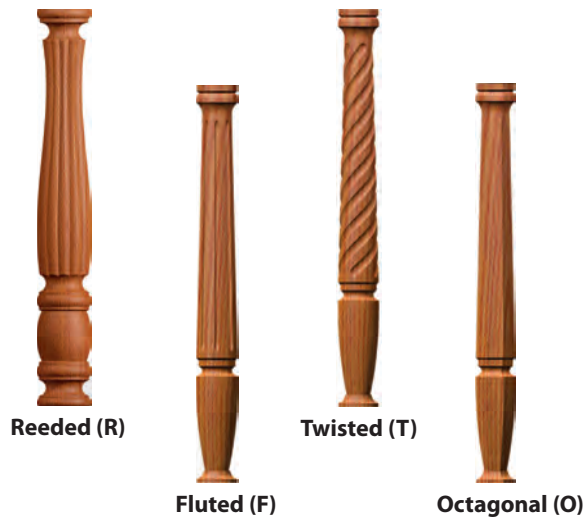
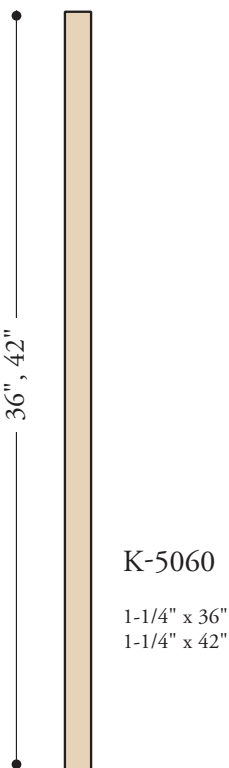
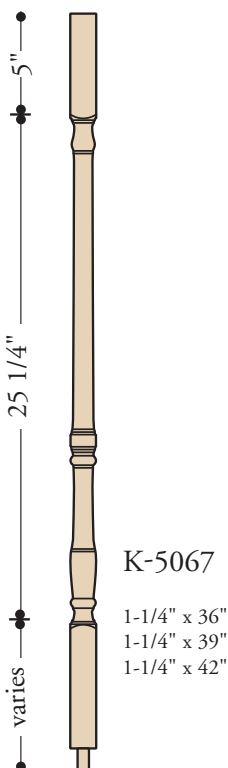
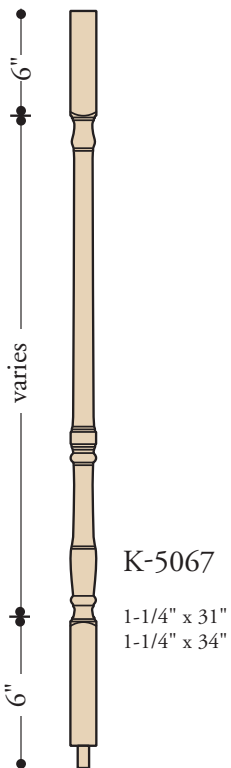
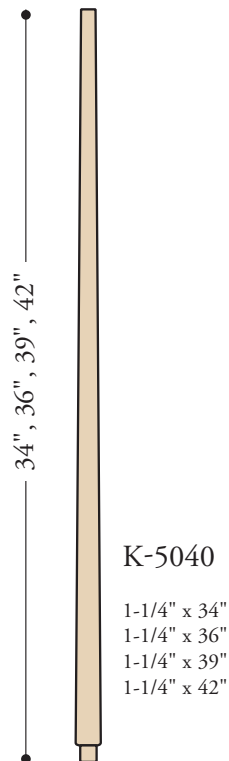
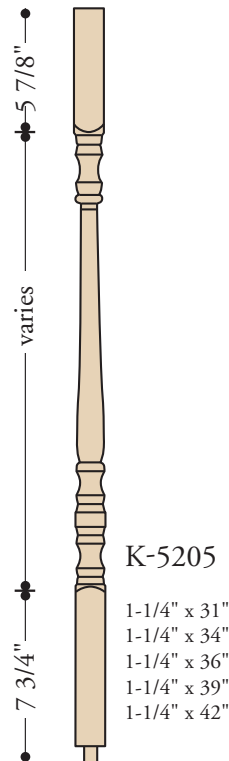
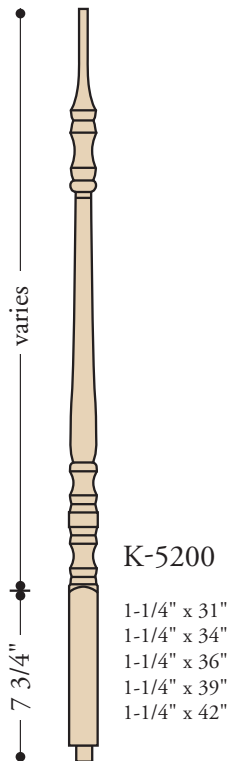
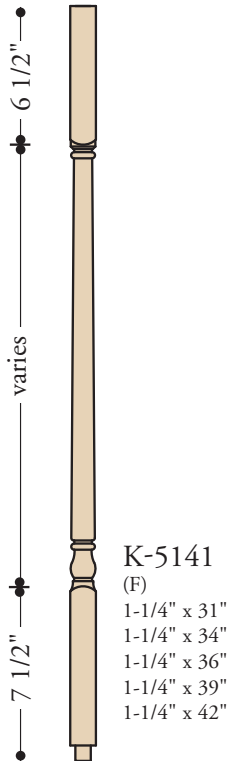
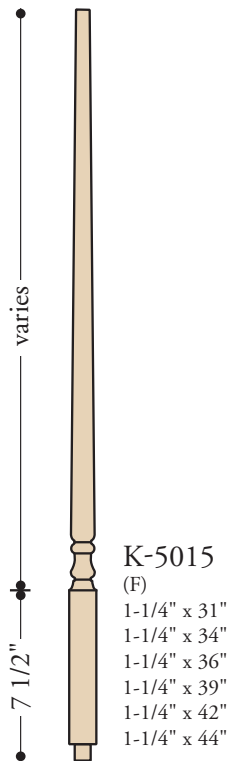

Several balusters and newels are also available in Reeded, Twisted, Fluted, and Octagonal as designated with a **R** (Reeded), **T** (Twisted), **F** (Fluted), or **O** (Octagonal) below the corresponding part numbers. Call for pricing and lead times.

BALUSTERS

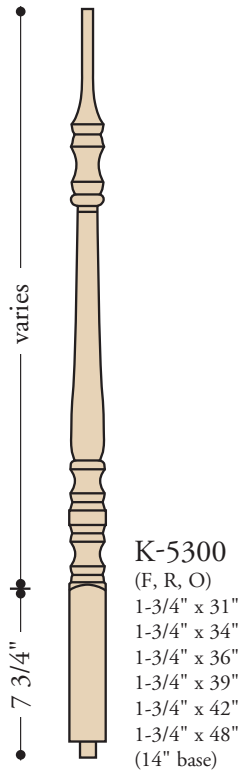

K-5300
(F, R, O)
1-3/4" x 31"
1-3/4" x 34"
1-3/4" x 36"
1-3/4" x 39"
1-3/4" x 42"
1-3/4" x 48"
(14" base)

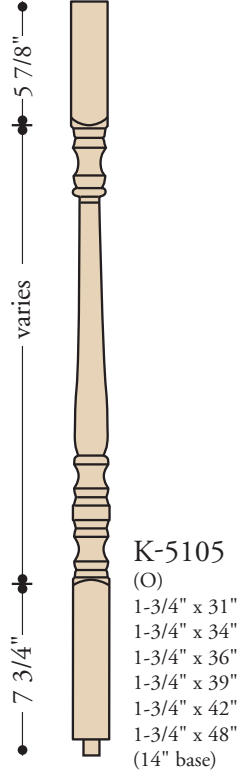

K-5105
(O)
1-3/4" x 31"
1-3/4" x 34"
1-3/4" x 36"
1-3/4" x 39"
1-3/4" x 42"
1-3/4" x 48"
(14" base)

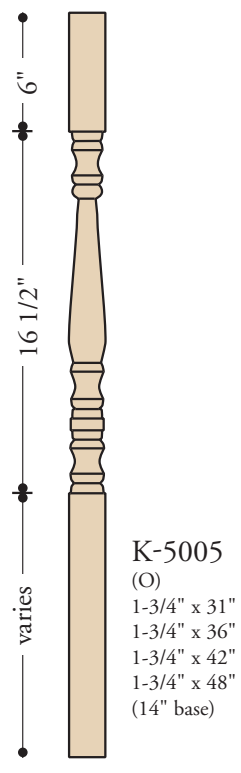

K-5005
(O)
1-3/4" x 31"
1-3/4" x 36"
1-3/4" x 42"
1-3/4" x 48"
(14" base)

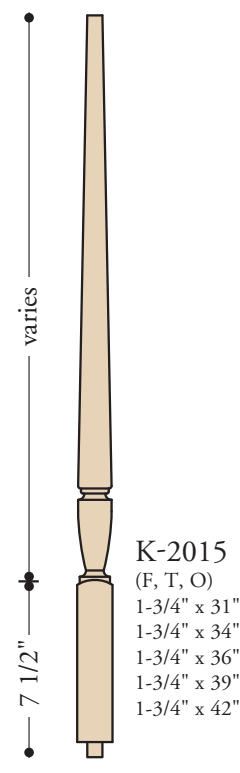

K-2015
(F, T, O)
1-3/4" x 31"
1-3/4" x 34"
1-3/4" x 36"
1-3/4" x 39"
1-3/4" x 42"

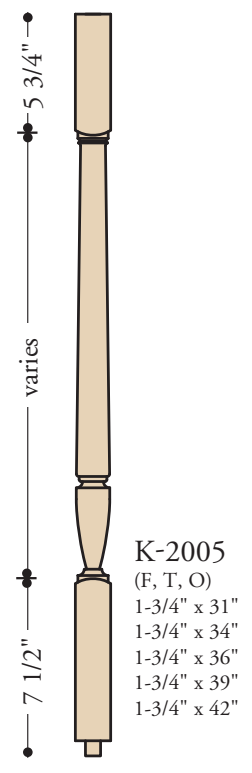

K-2005
(F, T, O)
1-3/4" x 31"
1-3/4" x 34"
1-3/4" x 36"
1-3/4" x 39"
1-3/4" x 42"

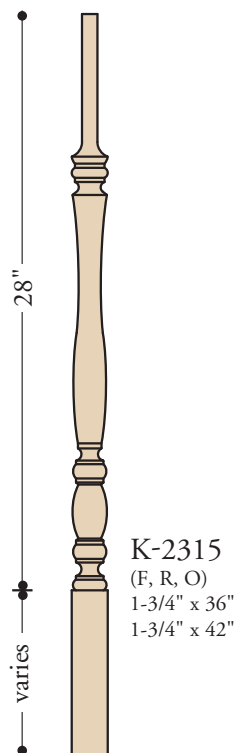

K-2315
(F, R, O)
1-3/4" x 36"
1-3/4" x 42"

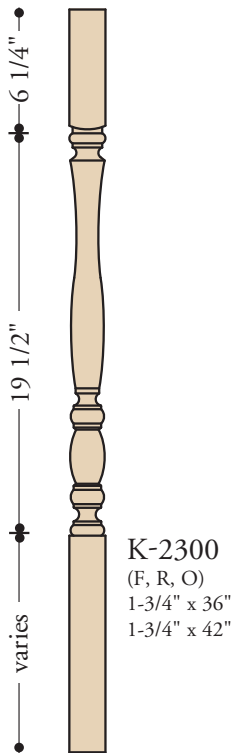

K-2300
(F, R, O)
1-3/4" x 36"
1-3/4" x 42"

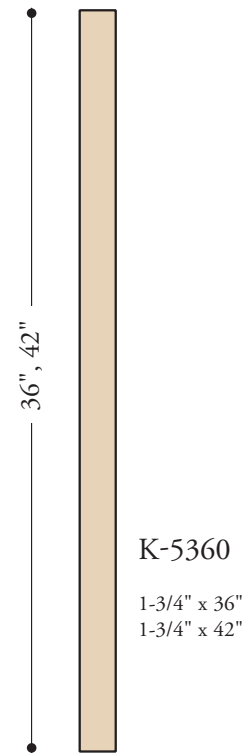

K-5360
1-3/4" x 36"
1-3/4" x 42"

FITTINGS

STARTING FITTINGS FOR K-6010 & K-6210 RAIL PROFILES

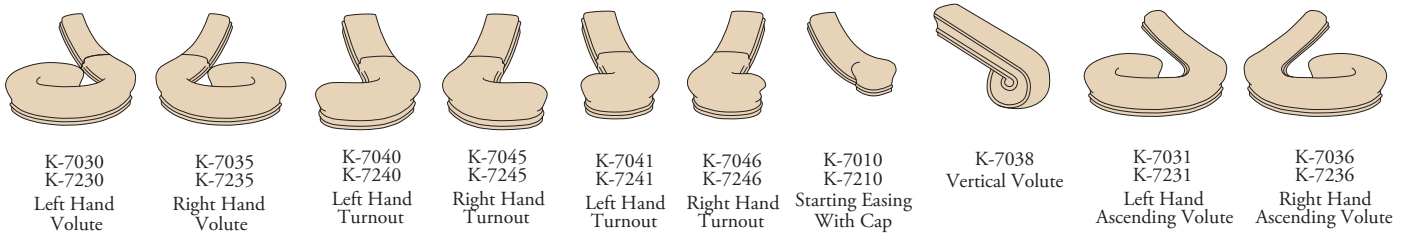

TRANSITION FITTINGS FOR K-6010 & K-6210 RAIL PROFILES

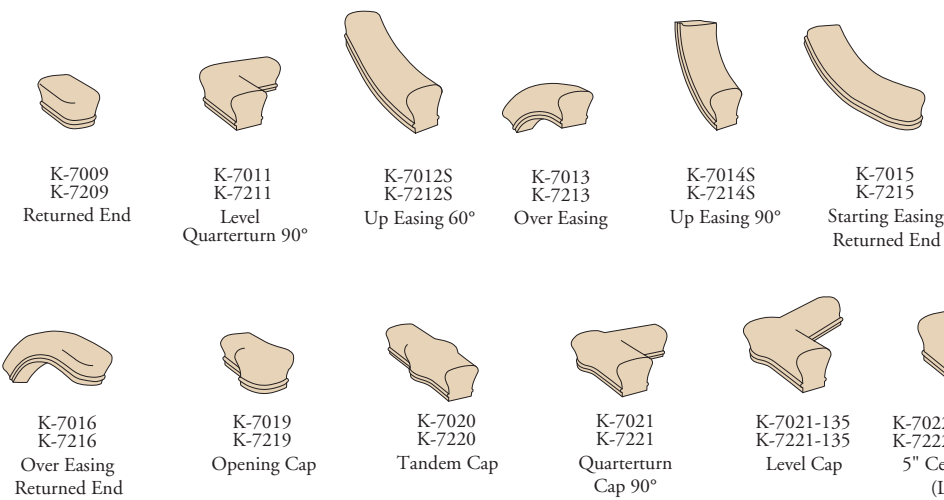

HOW TO ORDER FITTINGS

The second digit of the fitting part number must match the second digit of the rail part number.

Example:

K-70XX Fitting = K-6010 Rail

K-72XX Fitting = K-6210 Rail

GOOSENECK FITTINGS FOR K-6010 & K-6210 RAIL PROFILES

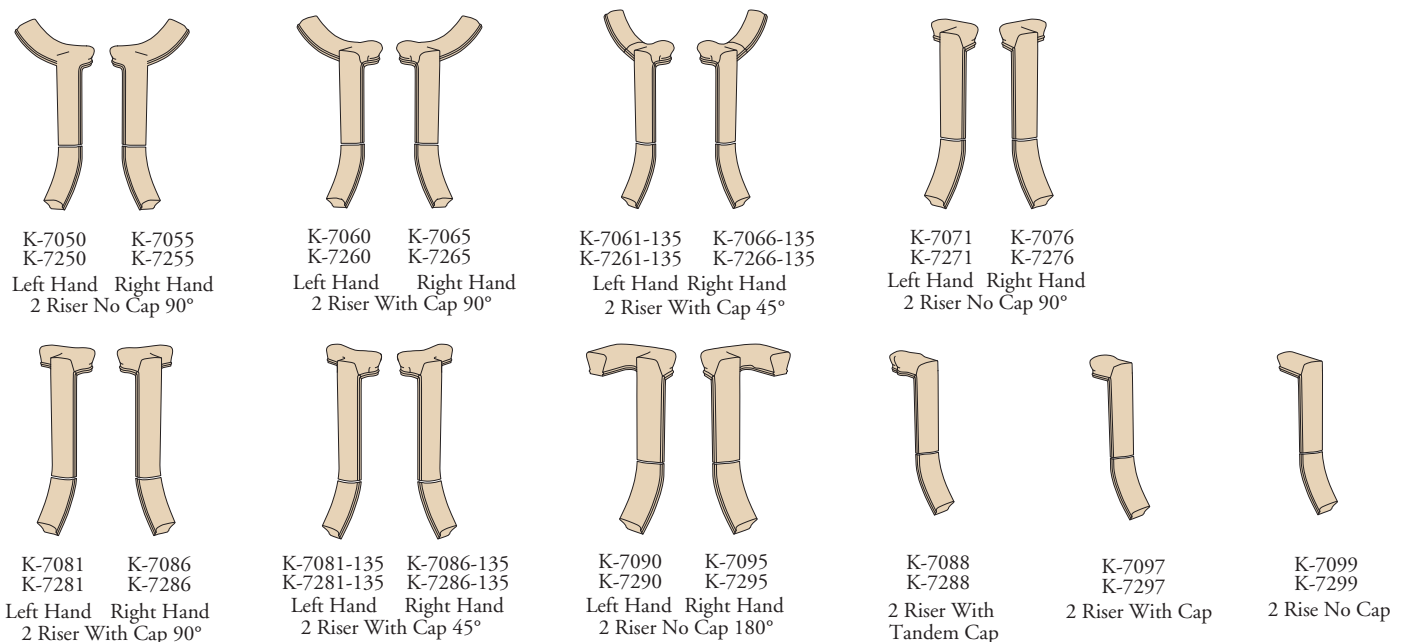

STARTING FITTINGS FOR K-6519, 6710 & K-6910 RAIL PROFILES

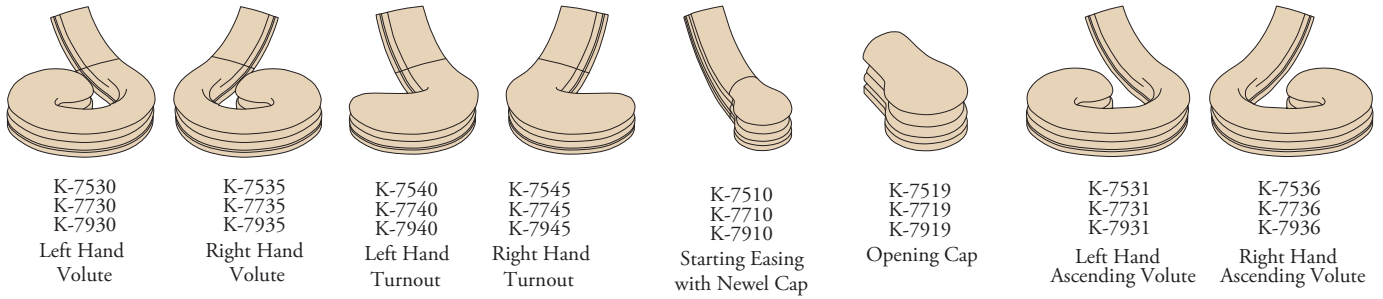

TRANSITION FITTINGS FOR K-6519, 6710 & K-6910 RAIL PROFILES

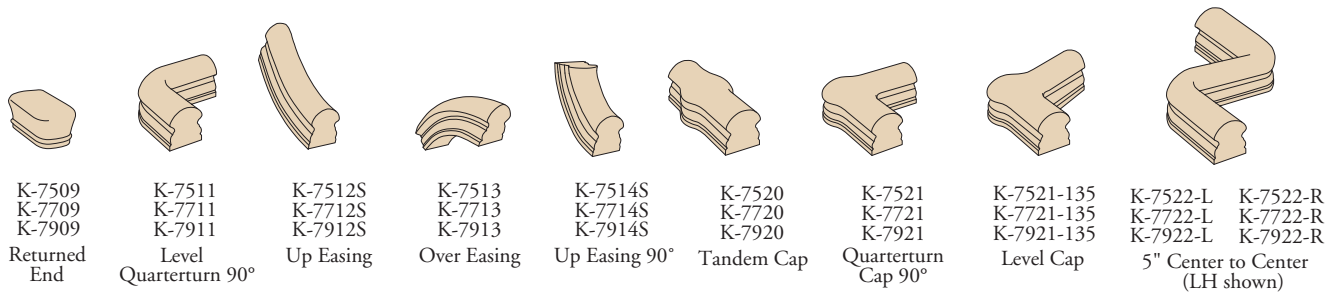

GOOSENECK FITTINGS FOR K-6519, 6710 & K-6910 RAIL PROFILES

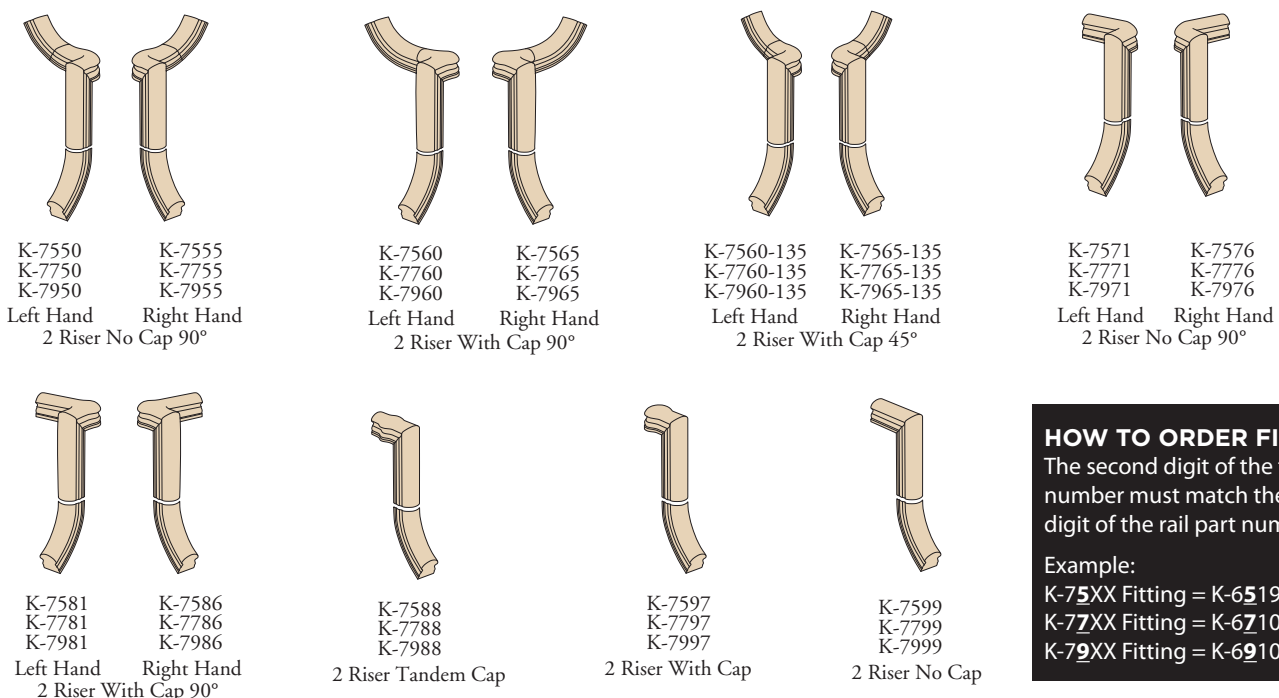

HOW TO ORDER FITTINGS
 The second digit of the fitting part number must match the second digit of the rail part number.

Example:
 K-75XX Fitting = K-6519 Rail
 K-77XX Fitting = K-6710 Rail
 K-79XX Fitting = K-6910 Rail

TREADS, RISERS & ACCESSORIES

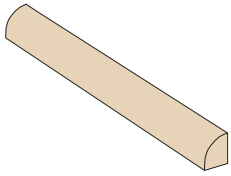

Shoe Mould
1624-A
1/2" x 3/4"

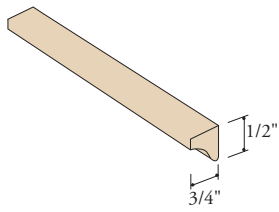

Cove Mould
1624-C
1/2" x 3/4"

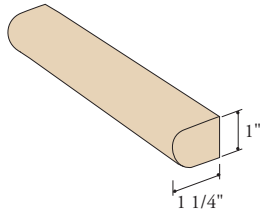

Nosing
K-8080
1-1/4" x 1"

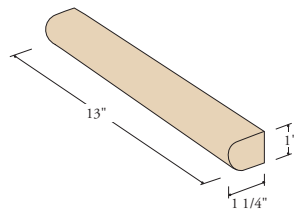

13" Return Nosing
K-8080-13
1-1/4" x 1"

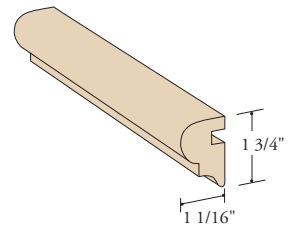

Nosing and Cove
K-8081
1-1/16" x 1-3/4"

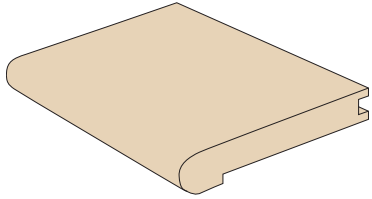

5-1/4" Landing Tread
32168-34-LTG for 3/4" floor
32168-12-LTG for 1/2" floor

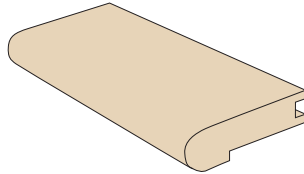

3-1/2" Landing Tread
32112-34-LTG
for 3/4" floor

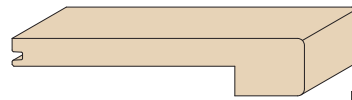

5-1/4" Landing Tread
32168-12-2RE18-LTG
for 1/2" floor

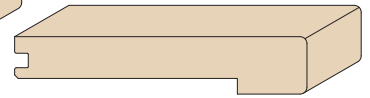

5-1/4" Landing Tread
32168-34-2RE18-LTG
for 3/4" floor

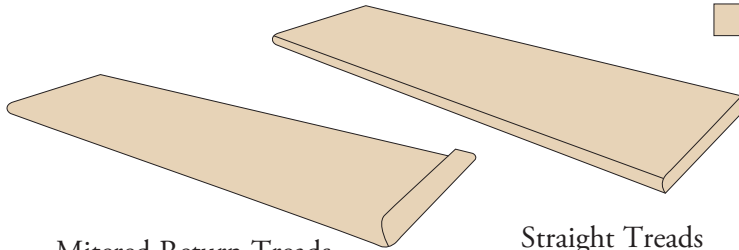

Mitered Return Treads
Available with Single or
Double Returned Ends
(RH Shown)

Straight Treads

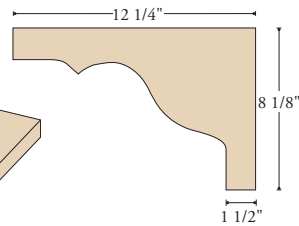

Tread Bracket
K-8028
1/4" thick

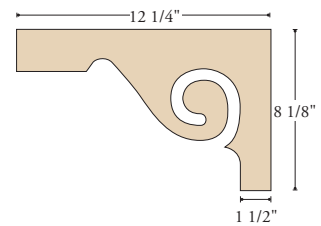

Tread Bracket
K-8029
1/4" thick

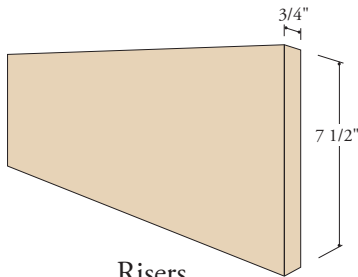

Risers

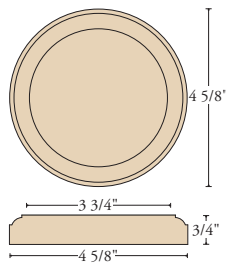

Rosette
K-7317

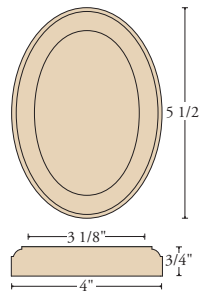

Rosette
K-7337

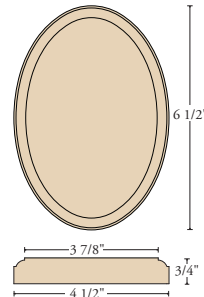

Rosette
K-7337-L

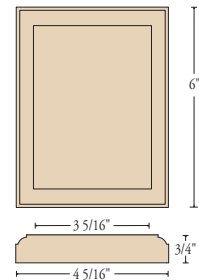

Rosette
K-7318

11-1/4" SKIRTBOARDS

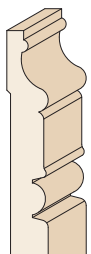

22360-E-B

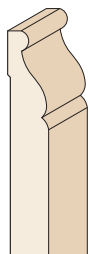

22360-CB

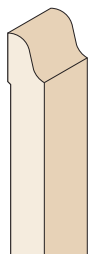

18360-OG-B

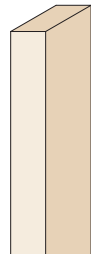

24360-S4S



20360-1R18-B

TREADS, RISERS & ACCESSORIES / STARTING STEPS

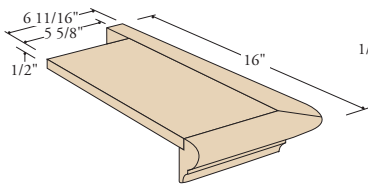

Tread Cap w/Mitered Return
K-8071
 5-5/8" x 11-1/2"
 Specify LH or RH
 (RH Shown)

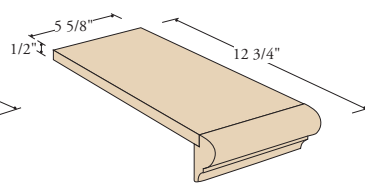

Tread Cap
K-8072
 5-5/8" x 11-1/2"

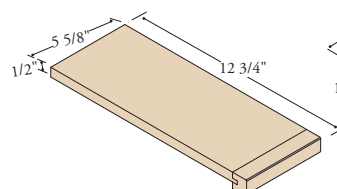

K-8072-2RE18
 5-5/8" x 11-1/2"

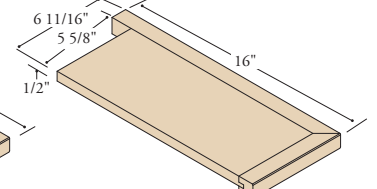

K-8071-2RE18
 5-5/8" x 11-1/2"
 Specify LH or RH
 (RH Shown)

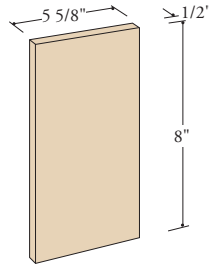

Riser Cap
K-8076
 4-3/4" x 8"

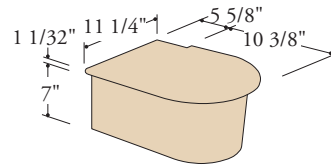

Starting End Cap
K-8011
 Specify LH or RH
 (RH Shown)

STARTING STEPS

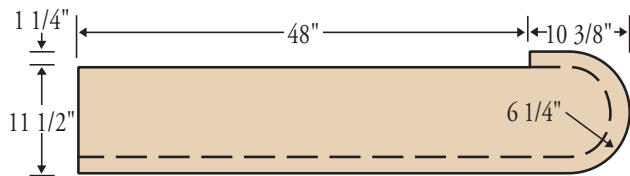

K-8010

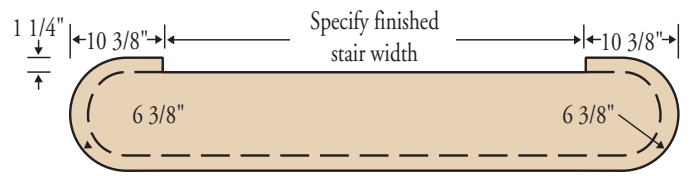

K-8015

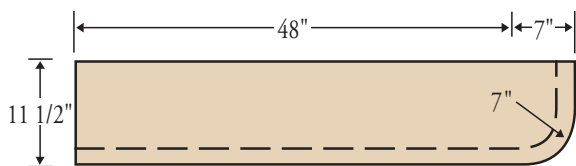

K-8040

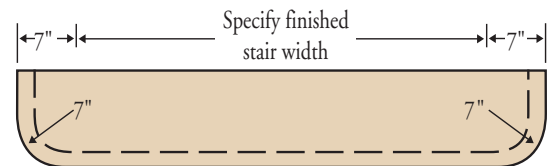

K-8060

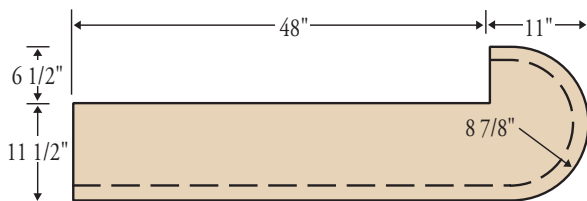

K-8030

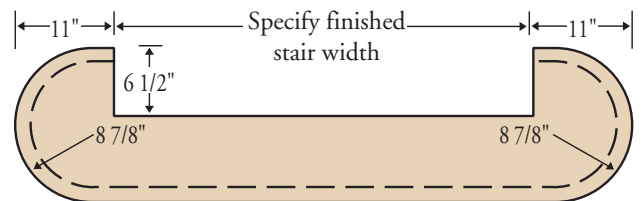

K-8050

All starting steps are shipped complete including the tread, riser, cove and shoe moulding.
 Custom sized/shaped starting steps are available on a special order basis.

HARDWARE

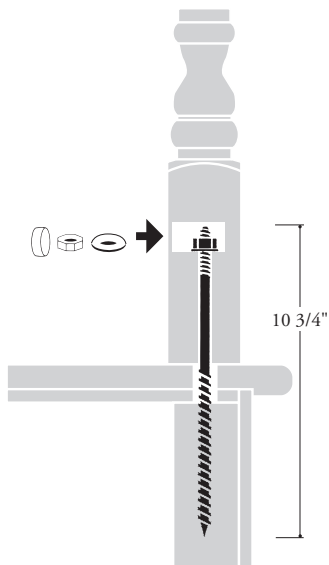

K-3008
Sure Tite
Newel Fastening System
 Includes: Lag Bolt, Washer,
 Nut & 1-1/2" Plugs

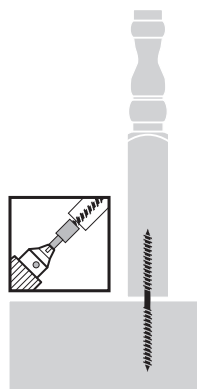

K-201B
1/4" Baluster Fastener
Drill Driver

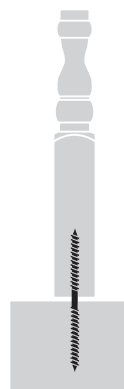

K-3202
 20-pack
1/4" x 2" Baluster Fasteners

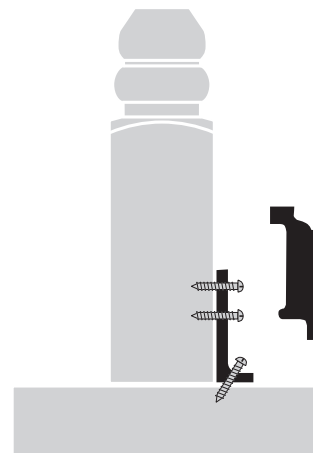

K-3505-30 - 3"
K-3505-35 - 3-1/2"
L-Bracket Post Fastener

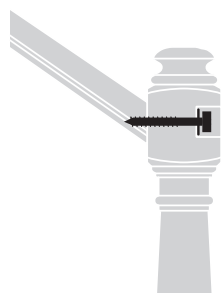

K-3301
Rail & Post Fastener
 Includes: Fastener, Washer,
 Nut & 1" Plugs

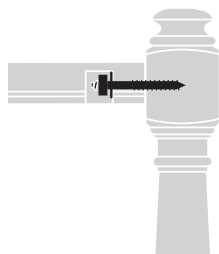

K-3302
Rail Bolt Fastener
 Includes: Fastener, Washer,
 Nut & Plugs

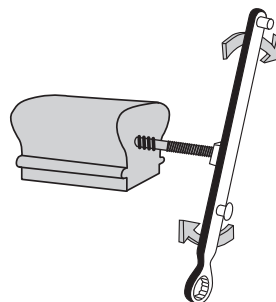

K-3901
Rail Bolt Wrench

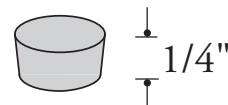

K-3000
Flush Rail Plug
 1" Diameter

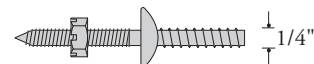

K-3001
3-1/2" Rail Bolt

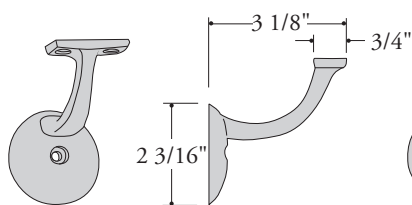

K-3601
Heavy Duty Wall
Rail Bracket
 (Available in Antique Brass,
 Bright Brass and Nickel Finish)

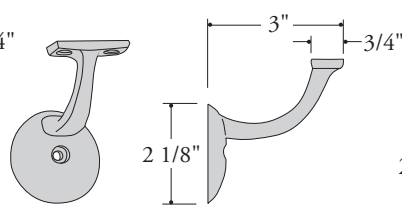

K-9802
Heavy Duty Wall
Rail Bracket
 (Available in Matte Black,
 Oil Rubbed Bronze, Satin Black
 and Silver Vein Finish)

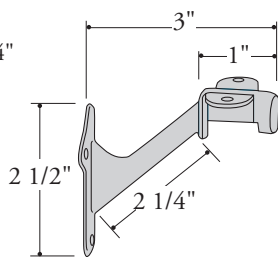

K-3002
Wall Rail Bracket
 (Brass Finish)

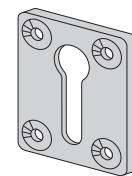

K-3283
Key Lock
 2" x 2-5/8" x 3/8"

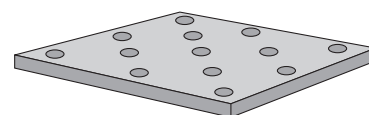

K-3501
4-5/8" Rail Plate
 Includes: Plate and
 13-3" Fastening Screws

COVER IMAGE COURTESY OF:

Preston Allen Homes, IN
Stefanie Ratcliff, Designer

- Handrail/Newel: K-6350
- Baluster: K-9000TB-44"

PAGE 4:

- Handrail: K-6710-ST
- Newel: K-4091-F
- Balusters: K-2015

PAGE 8:

- Handrail: K-6210-ST-P1, K-6210-B bending rail
- Newel: K-4091-FP
- Baluster: K-5360

PAGE 12:

- Handrail: K-6210-ST
- Newel: By Others (similar to K-4091)
- Baluster: K-9068RB-96
- Intermediate Baluster: 1-1/2" x 2" S4S

PAGE 13 - IMAGE COURTESY OF:

ITC Millwork, Stallings/Raleigh, NC, Charleston, SC
New Old, LLC, Charlotte, NC, Southern Studio, NC, and
Michael Blevins Photography, Kernersville, NC

- Baluster: K-9088CS-44, K-9000TB-44
- Rail & Newel: By Others

PAGE 17:

ITC Millwork & Arcadia Homes
Stallings/Raleigh, NC and Charleston, SC,
Dustin Peck Photography, Charlotte, NC

- Handrail: K-6302
- Balusters: K-9068RB-96

PAGE 25 - IMAGE COURTESY OF:

Home Lumber of New Haven, New Haven, IN
Timberlin Homes, Ft. Wayne, IN

- Handrail: K-6210-ST-P1
- Newel: K-4891-FP
- Balusters: K-5360





Koetter Woodworking, Inc.
(812) 923-8875
800-411-8285 toll free fax
www.koetterwoodworking.com